

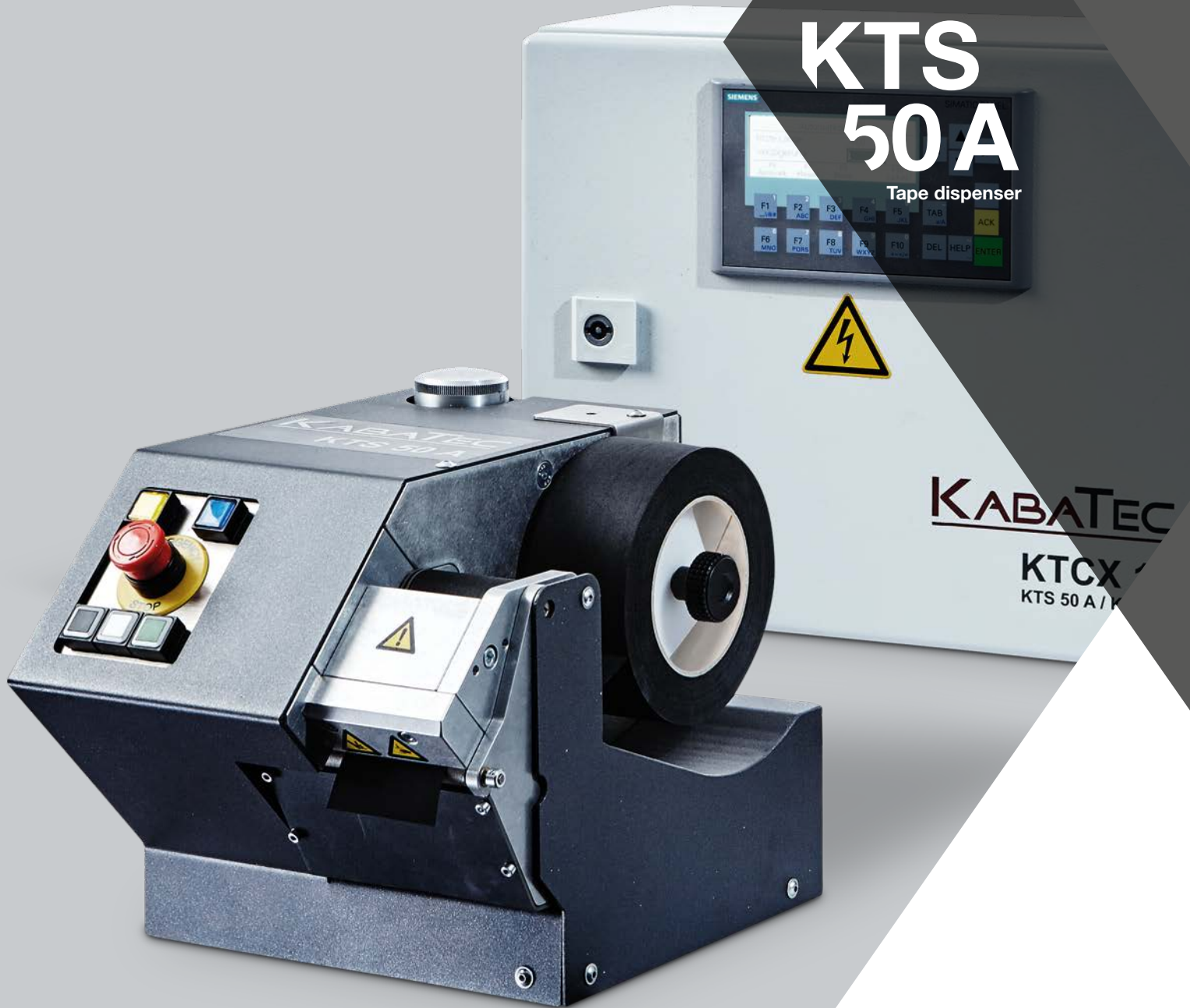

KTS 50 A

Tape dispenser



KABATEC
KTCX
KTS 50 A / K

komax

KTS 50 A

Space-saving and economical

The KTS 50 A tape dispenser has been specially developed for processing industrial tapes with high pull-off forces. The tape pull-off speed can be adjusted to meet the requirements of the different tape strengths and qualities. The KTS 50 A can communicate directly with the welding machine via the control unit. With its compact dimensions, the tape dispenser fits on the welding taping machine table directly next to the harness board, making handling particularly economical in the usually cramped conditions of cable harness production. The user-friendly operator interface can be adapted to individual needs and offers rapid access to the relevant machining parameters.



- 
- COMPACT
 - HIGH PERFORMANCE
 - FLEXIBLE

◀ The KTS 50 A tape dispenser offers a high degree of flexibility and reliability when processing especially robust adhesive tapes of different qualities.

AUTOMATED TAPE DISPENSER

EFFICIENT WORK ON THE HARNESS BOARD

In cable harness production, flexibility is a vital criterion for fast and economical working. Different cable cross-sections and bundles, as well as different types of adhesive tape require agile machines with easily parameterizable program cycles.

The KTS 50 A is also characterized by flexibility and user-friendliness in terms of tape length: Up to 12 different sequences with user-defined adhesive tape lengths can be stored. The programmable tape length is between 30 and 9,999 mm. Once the tape has been pulled off, the machine outputs the corresponding tape lengths sequentially. This means that the KTS 50 A, for example, is ideally suited for fastening cable harnesses to the roof lining or in the vehicle body. Another field of application is in the

manual bundling of cable harnesses: The items with different cross-sections can be processed in sequence and the ideal tape length is always dispensed. This is where the KTS 50 A comes into its own, as its major advantage is that it communicates directly with the welding machine and can take over the determined cable cross-sections from the welding machine. The next welding cycle can be automatically stopped until the operator has removed the tape section from the KTS 50 A.

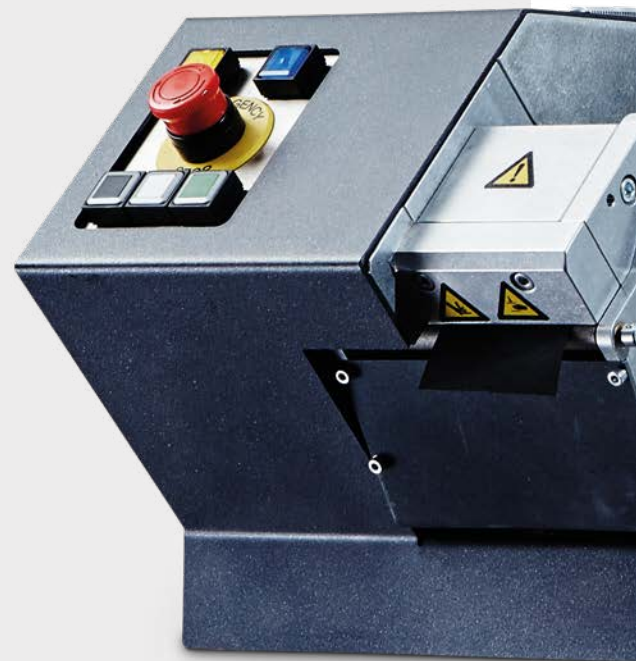

Excellent cutting

One outstanding quality feature of the KTS 50 A is the quality of the blades, which have been specially developed by Komax for processing adhesive tape. At its factory, Komax attaches great importance to finishing. The result is an excellent cutting performance and extremely high stability – characteristics that pay off when the machine is in daily use.

High flexibility for individual work

- The programmed tape length is output manually.
- Programmed tape lengths are processed in sequence.
- Automatic processing after the welding machine has processed the splice. The tape length is dependent on the cross-section data transmitted by the welding machine.
- Up to 12 different tape lengths are stored.
- Three speed levels: Motor speeds can be individually adapted to different types of adhesive tape. For one thing, a higher pull-off force for heavy adhesive tapes is possible, while on the other hand, unstable tapes can be easier to process thanks to individual settings.

Robust - reliable - tried and tested

- The tape dispenser ensures constant processing and reproducible quality that meets the highest requirements.
- A quality advantage through high-quality and tried-and-tested components; robust and a German-made low-maintenance shear blade.

User-friendliness combined with low maintenance needs

- The desired adhesive tape length can be conveniently entered at the touch panel.
- The maintenance and oiling intervals are shown automatically on the display.



KABATEC
KTCX 10
KTS 50 A / KTSB 6

◀ The KTS 50 A tape dispenser processes tape widths from 9 to 50 mm. The KTCX 10 control module communicates with the welding machine.

01 Three operating modes - manual, sequential and automatic - permit flexible adaptation to production needs.

02 A razor-sharp quality advantage: Komax relies on a high level of vertical integration.

03 Cross-section data with a programmed tape length for different cable cross-sections.



01

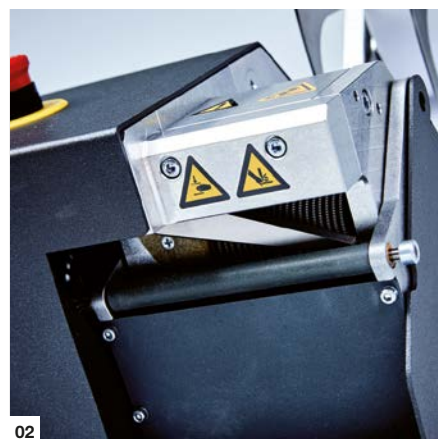

02

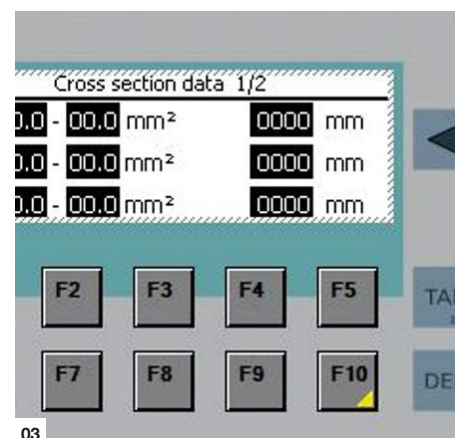

03

Cross section data 1/2			
0.0 - 00.0	mm ²	0000	mm
0.0 - 00.0	mm ²	0000	mm
0.0 - 00.0	mm ²	0000	mm





01

ADVANCED FUNCTIONALITY

KOMAX OFFERS TAILOR-MADE SOLUTIONS AND EQUIPMENT WHEN THE CUSTOMER CALLS FOR THEM

No adhesion: Air nozzle

Thin and light adhesive tapes fold back quickly. To prevent this, an air nozzle can be fitted as an option. It stabilizes the adhesive tape with an air blast (see arrows in the image below). This is a clear advantage during handling, because this way, the tape does not adhere and is easier to remove. Another clever detail: The air blast can be made stronger or weaker by means of a throttle.



02

Processing special tapes with precision: Pressure roller

An additional pressure roller can be installed for PVC adhesive tapes that have a high pull-off force. This presses the adhesive tape onto the feed roller, so ensuring optimal processing.

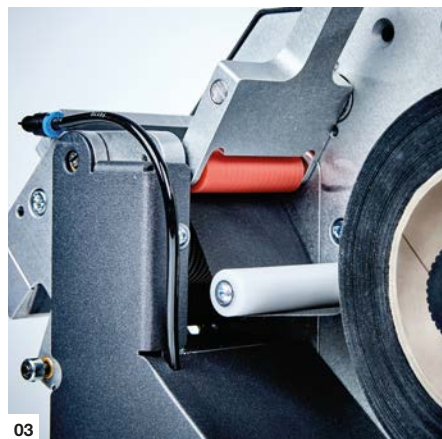

03

Always perfectly oiled: Manual oiling device

The oil consumption also varies, depending on the adhesive tape. The manual oiling device is recommended for use with fleece tape and thick textile tapes in order to achieve a consistent cut quality. No adhesive remains on the blade. In addition, the number of oiling cycles can be set individually. This prevents residues from forming on the adhesive tape as a result of excessive oiling.



04

01 Colour-coded operation

02
An optional air nozzle prevents light adhesive tapes from folding back.

03
Pressure roller helps in processing adhesive tapes with a high pull-off force.

04
The manual oiling device ensures a constant quality of cut, especially with thick adhesive tapes.

Technical Data

Application	Dispensing and supply of adhesive tape sections of various types and lengths
Material	Most commercially available tape (PVC, Cloth, Fleece, PP film)
Programmable tape length	30 mm to 9,999 mm
Tape width	9 mm–50 mm
Tape holding arbor (standard)	1,5" and 3"
Tape roll outer diameter	160 mm
Noise emission value	<85 dB
Dimension (H/W/D)	KTS 50 A: 282 mm / 225 mm / 302 mm KTCX10 (control unit): 337 mm / 412 mm / 218 mm
Pneumatic connection	6 bar (0.6 Mpa / 87 psi)
Connection	1-phase 230V, 50Hz
Weight	KTS 50 A: 11 kg KTCX10 (control unit): 12 kg

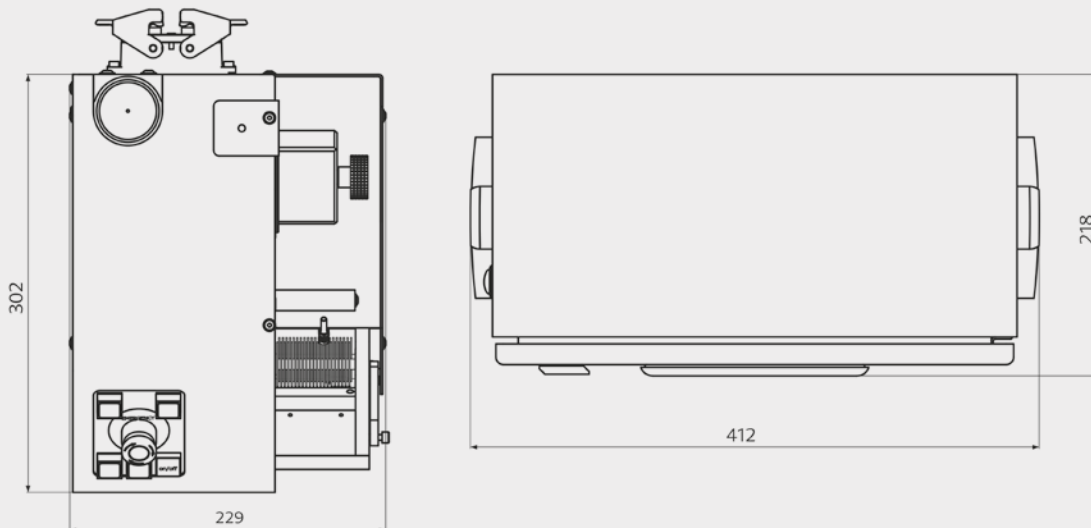

FEASIBILITY ANALYSIS

OUR OFFER FOR YOU

The combinations of different cable variants and adhesive tapes have an enormous influence on the quality of the spot taping process. This is why we offer a feasibility analysis:

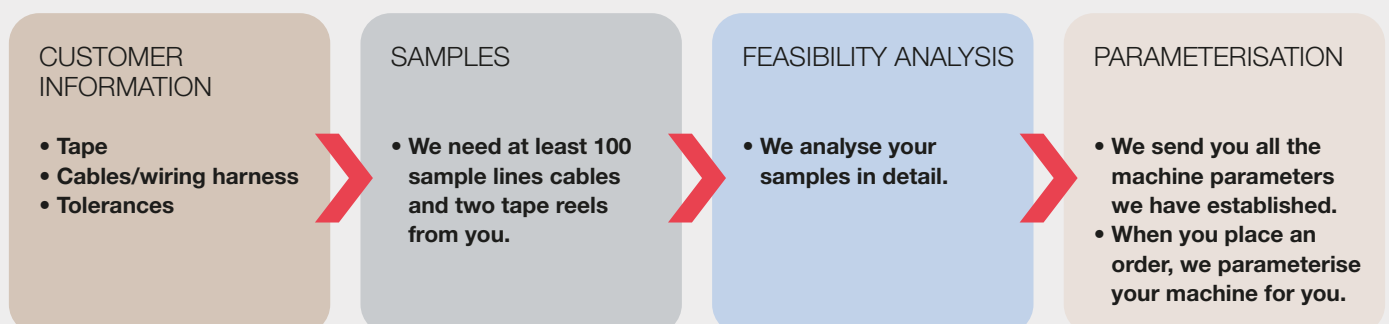

Komax – leading the field now and in the future

As a pioneer and market leader in the field of automated wire processing, Komax provides its customers with innovative and sustainable solutions for any situation that calls for precise contact connections. Komax manufactures series and customer-specific machinery for various industries, catering to every degree of automation and customization. Its range of quality tools, test systems, and intelligent networking solutions complete the portfolio, and ensure safe and efficient production.

Komax is a globally active Swiss company with development and production facilities on several continents. Komax uses its extensive distribution and service network, which includes local companies and their employees, to support customers across the world on site, thus ensuring the availability and value of their investments after equipment commissioning through standardized service processes.